

Chapter 7A compliant: Tested and listed to ASTM2886.
OSFM BML listing: 8165-2192, ICC-ESL listing: 1299, 1300

1 Hour Fire Rated, ICC-ESL listing: 1299. **Canadian Compliance** : ICC-ESL: 1455 [CAN/ULC-S101-14]

WWW.VULCANVENTS.COM (916) 652-7424 info@newcalmetals.com P.O. Box 1126 Loomis, CA. 95650



For use to comply with SB 721, SB 326 where decks and balconies (EEE) require inspection.

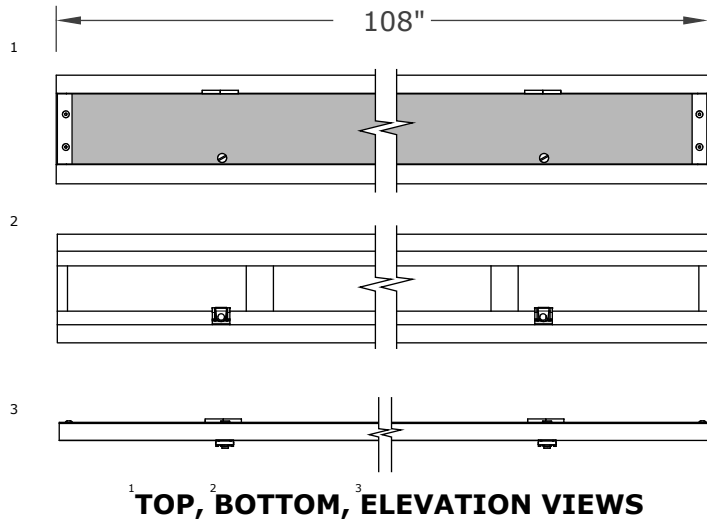
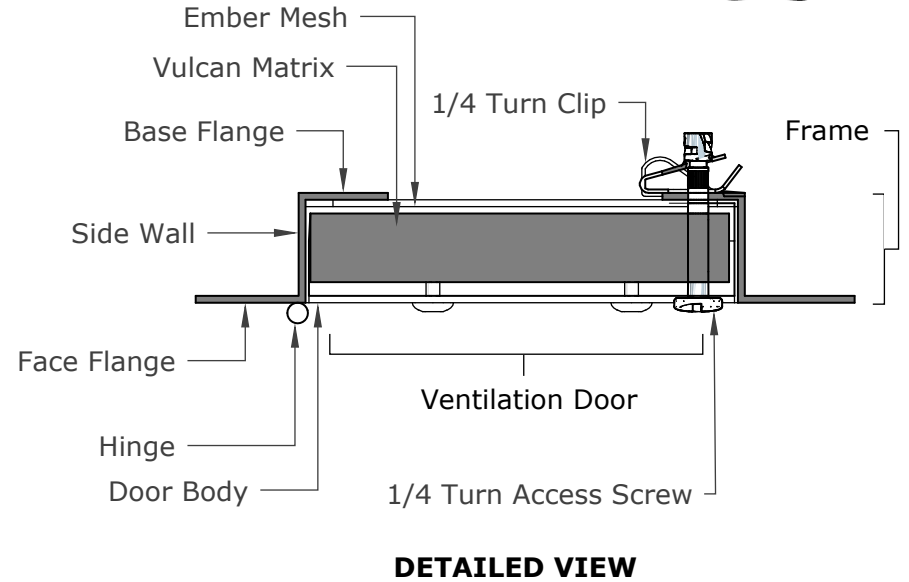
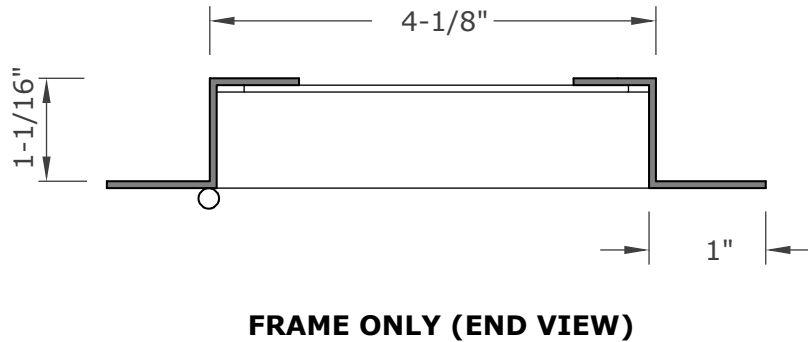

Installation Notes:

Remove door before installation. Base flange is recommended for mounting.

Apply **EverKem 814+ intumescent fire caulking** or similar on back side of face flange and side wall prior to installation.

Use min #12 x 1-1/2", pancake head fasteners, 2 per joist w/ max span of 24".
Min fastener shank penetration into joist: 1-1/2".
When mounting depth is greater than 1", consider furring strips.

For detailed installation examples, please visit: www.vulcanvents.com

Non-fire rated and ember only options are available from New Cal Metals.

Proudly Manufactured By: NEW CAL METALS INC.

www.newcalmetals.com

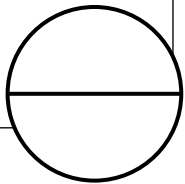

VSC4108IF PRODUCT SPECIFICATION & DATA SHEET

Model Description	Continuous	Flange Type	Inspection	Frame & Flange	G90 Galvanized Steel - 20GA
Model Number	VSC4108IF	NFVA	172 sq. in.	Ventilation Door	G90 Galvanized Steel - 24GA
Model Size	108" x 4"			Intumescent Core	5mm Hexagonal Matrix - Aluminum with intumescent coating
				Ember Mesh	14 Mesh - 304 Stainless Steel